

PROJECT	_____
TYPE	_____
SPECIFIER	_____
QUANTITY	_____
DATE	_____

## MECHANIQ ROUND COMFORT TRIMLESS

### A35004-

base number	LED Dimming	Color Temperature	Finishes (Diamond)	Finishes (Triangle)	Finishes (Circle)	Ceiling Thickness	Reflector Options
-------------	-------------	-------------------	--------------------	---------------------	-------------------	-------------------	-------------------

- To build a product code in our configurator select the specify button on the base model # product page
- To build a manual product code on this datasheet choose from the options listed below in blue font and add the suffix to the base model #

#### GENERAL

Series: Mechaniq Round Comfort  
 Subseries: Mechaniq Round Comfort  
 Brand: Prolight  
 Division: Architectural  
 Mounting Type: Trimless  
 Mounting Location: Ceiling  
 Subcategory: Downlight

#### PHYSICAL

Shape: Round  
 Diameter (mm): 131  
 Diameter (in): 5 3/16  
 Height (mm): 127  
 Height (in): 5  
 Ceiling Thickness (mm): 10 / 12 / 15 / 25  
 Ceiling Thickness (in): 3/8 or 1/2 or 9/16 or 1  
 Min. Recessing Depth (mm): 140  
 Min. Recessing Depth (in): 5 1/2  
 Light Distribution: Adjustable / Downlight  
 Weight (kg): 0.92  
 Weight (lbs): 2.02  
 Fixture Finish: SSR / BKV / CWI / CRY / HAB / UFT / ITA / RUA / FTG / MYG / LOD / PUS / FRO / FUP / KIA / POP / BLS / SPG / MEY / GOH / GUM / CHC / COM / ABZ / JAG / OBR / MOS / ROR  
 Fixture Material: Aluminum Die Cast  
 Cut-out Measurements: Ø 140mm / 5 1/2"  
 Upon Request: Unique Ceiling Thickness



#### ELECTRICAL

Lamp Type: LED (Zhaga Standard)  
 Input Wattage (W): 28.6  
 Total Output Wattage (W): 26.4  
 Dimming: Tri-Mode (Non-Dimming and Phase Dimming (120Vac only) and 0-10V Dimming)  
 Driver Included: No  
 Driver Location: Recessed Housing  
 Driver Type: Constant Current - Universal  
 Driver Class: Class 2  
 Housing: See components  
 Input Voltage (V): 120 - 277  
 Constant Current (MA): 700

#### LED

Number of LEDs: 1  
 Color Temperature (°K): 2700 / 3000 / 3500 / 4000  
 Max. Delivered Lumen (lm): 2210 / 2270 / 2319 / 2440  
 CRI: >90 CRI  
 Lamp Life (hrs): 50000  
 Upon Request: Special Color Temperature RGB-W Tunable White Special LED

#### OPTICAL

Reflector: 18 / 26 / 40  
 Adjustability: Rotational 355°; Tilt 30°  
 Upon Request: Special Beam Angles

#### RATINGS AND CERTIFICATIONS

Certified By: Certified for North American Standards  
 IP rating: IP44  
 Zaneen Group Inc. © 2024, T 1800-388-3382, F 416-247-9319, www.zaneen.com

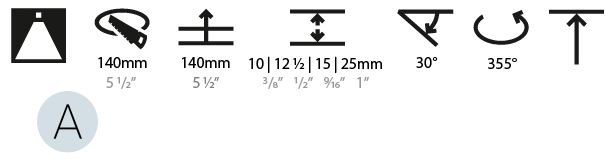
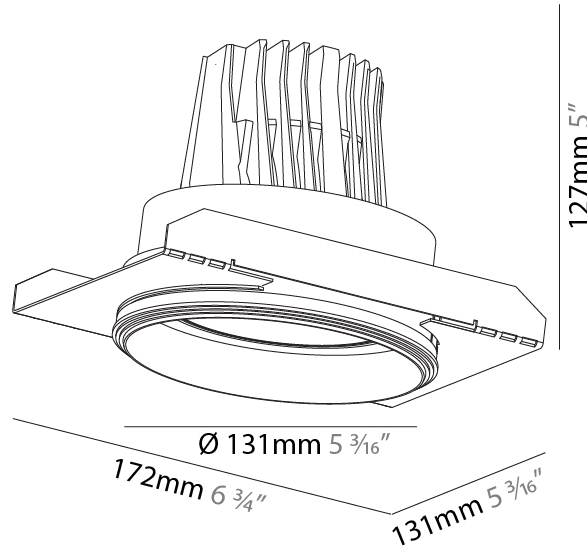

## MECHANIQ ROUND COMFORT TRIMLESS

A35004-

PROJECT	_____
TYPE	_____
SPECIFIER	_____
QUANTITY	_____
DATE	_____

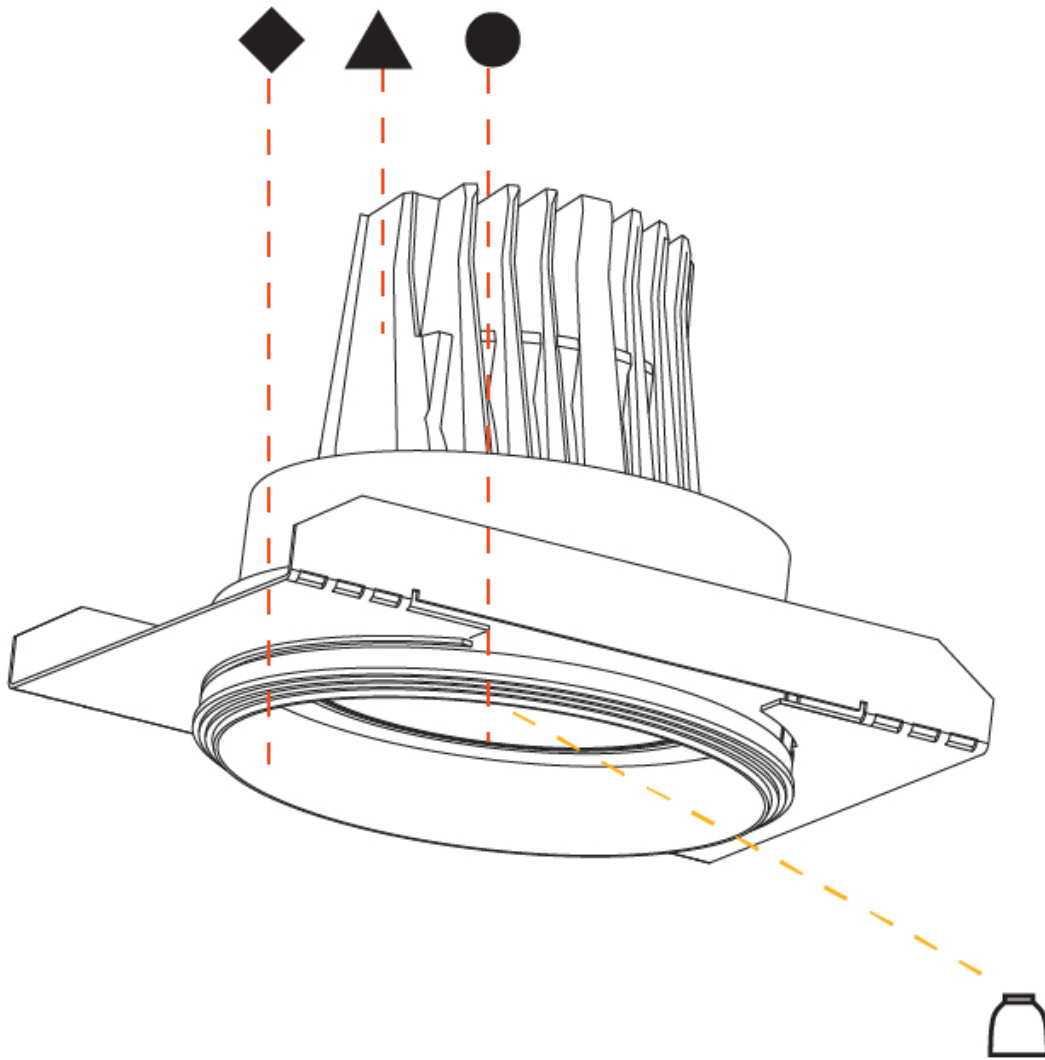

A

PROJECT	_____
TYPE	_____
SPECIFIER	_____
QUANTITY	_____
DATE	_____

## MECHANIQ ROUND COMFORT TRIMLESS

### A35007-

base number	LED Dimming	Color Temperature	Finishes (Diamond)	Finishes (Triangle)	Finishes (Circle)	Ceiling Thickness
-------------	-------------	-------------------	--------------------	---------------------	-------------------	-------------------

- To build a product code in our configurator select the specify button on the base model # product page
- To build a manual product code on this datasheet choose from the options listed below in blue font and add the suffix to the base model #

#### GENERAL

Series: Mechaniq Round Comfort  
 Subseries: Mechaniq Round Comfort  
 Brand: Prolight  
 Division: Architectural  
 Mounting Type: Trimless  
 Mounting Location: Ceiling  
 Subcategory: Downlight

#### PHYSICAL

Shape: Round  
 Diameter (mm): 180  
 Diameter (in): 7 1/16  
 Height (mm): 180  
 Height (in): 7 1/16  
 Ceiling Thickness (mm): 10 / 12 / 15 / 25  
 Ceiling Thickness (in): 3/8 or 1/2 or 9/16 or 1  
 Min. Recessing Depth (mm): 200  
 Min. Recessing Depth (in): 7 7/8  
 Light Distribution: Downlight  
 Weight (kg): 2.05  
 Weight (lbs): 4.51  
 Fixture Finish: SSR / BKV / CWI / CRY / HAB / UFT / ITA / RUA / FTG / MYG / LOD / PUS / FRO / FUP / KIA / POP / BLS / SPG / MEY / GOH / GUM / CHC / COM / ABZ / JAG / OBR / MOS / ROR  
 Fixture Material: Aluminum Die Cast  
 Cut-out Measurements: Ø 190mm / 7 1/2"  
 Upon Request: Unique Ceiling Thickness

#### ELECTRICAL

Lamp Type: LED (Zhaga Standard)  
 Input Wattage (W): 23.2  
 Total Output Wattage (W): 21.2  
 Dimming: Tri-Mode (Non-Dimming and Phase Dimming (120Vac only) and 0-10V Dimming)  
 Driver Included: No  
 Driver Location: Recessed Housing  
 Driver Type: Constant Current - Universal  
 Driver Class: Class 2  
 Housing: See components  
 Input Voltage (V): 120 - 277  
 Constant Current (MA): 700

#### LED

Number of LEDs: 1  
 Color Temperature (°K): 2700 / 3000 / 3500 / 4000  
 Max. Delivered Lumen (lm): 1440 / 1490 / 1568 / 1600  
 CRI: >90 CRI  
 Lamp Life (hrs): 50000  
 Upon Request: Special Color Temperature RGB-W Tunable White Special LED

#### OPTICAL

Reflector°: 8  
 Adjustability: Rotational 355°; Tilt 30°  
 Upon Request: Special Beam Angles

#### RATINGS AND CERTIFICATIONS

Certified By: Certified for North American Standards  
 IP rating: IP44  
 Zaneen Group Inc. © 2024, T 1800-388-3382, F 416-247-9319, www.zaneen.com

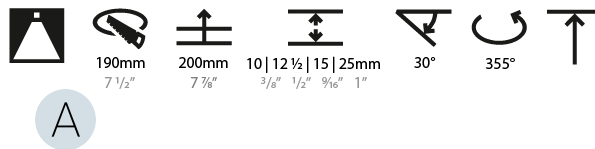
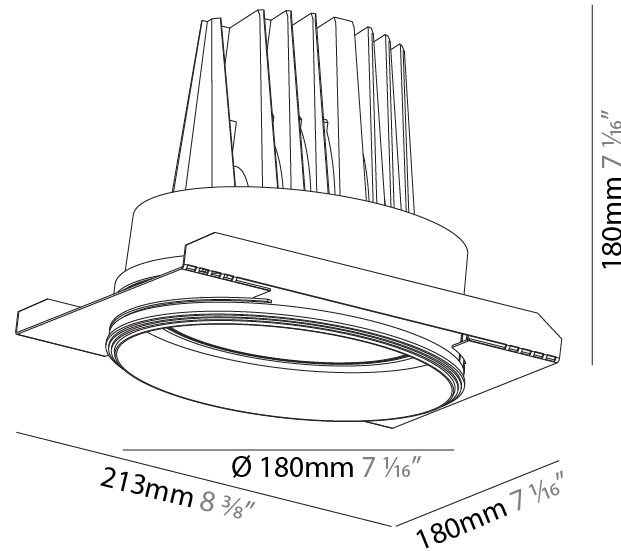

## MECHANIQ ROUND COMFORT TRIMLESS

A35007-

PROJECT	_____
TYPE	_____
SPECIFIER	_____
QUANTITY	_____
DATE	_____

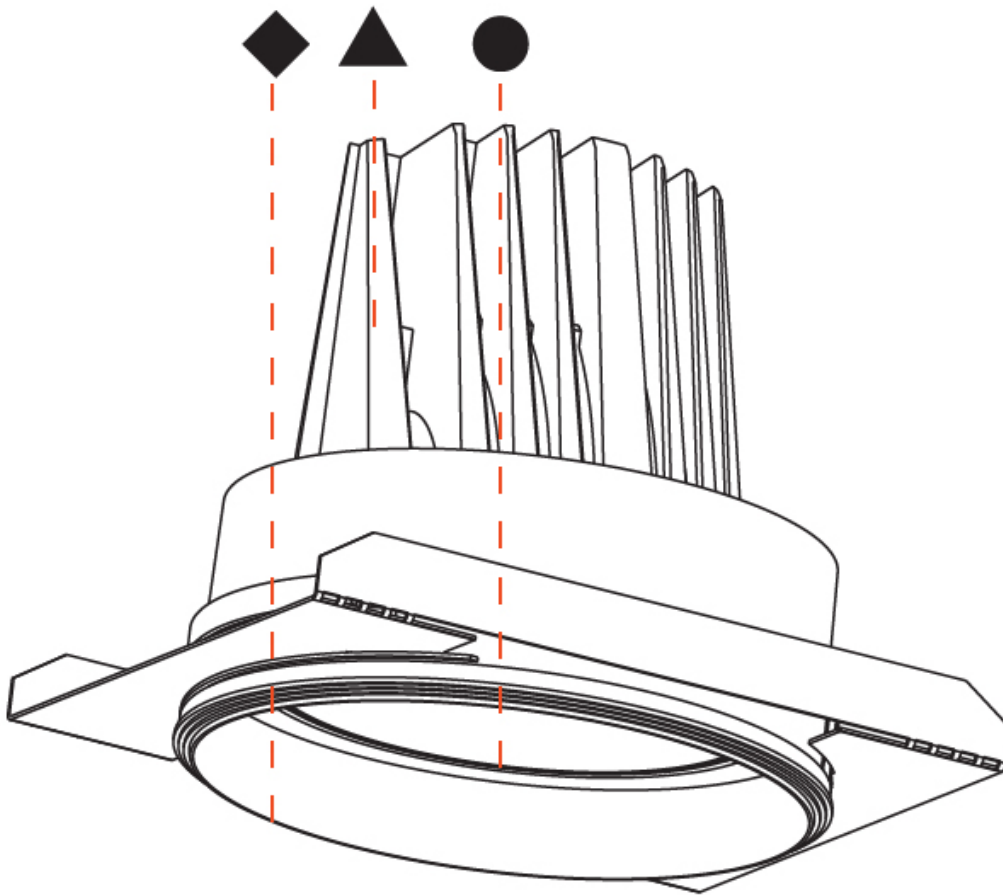

## MECHANIQ ROUND COMFORT TRIMLESS

### A35010-

base number LED Dimming Color Temperature Finishes (Diamond) Finishes (Triangle) Finishes (Circle) Ceiling Thickness Reflector Options

- To build a product code in our configurator select the specify button on the base model # product page
- To build a manual product code on this datasheet choose from the options listed below in blue font and add the suffix to the base model #

#### GENERAL

Series: Mechaniq Round Comfort  
 Subseries: Mechaniq Round Comfort  
 Brand: Prolight  
 Division: Architectural  
 Mounting Type: Trimless  
 Mounting Location: Ceiling  
 Subcategory: Downlight

#### PHYSICAL

Shape: Round  
 Diameter (mm): 180  
 Diameter (in): 7 1/16  
 Height (mm): 180  
 Height (in): 7 1/16  
 Ceiling Thickness (mm): 10 / 12 / 15 / 25  
 Ceiling Thickness (in): 3/8 or 1/2 or 9/16 or 1  
 Min. Recessing Depth (mm): 200  
 Min. Recessing Depth (in): 7 7/8  
 Light Distribution: Adjustable / Downlight  
 Weight (kg): 2.048  
 Weight (lbs): 4.51  
 Fixture Finish: SSR / BKV / CWI / CRY / HAB / UFT / ITA / RUA / FTG / MYG / LOD / PUS / FRO / FUP / KIA / POP / BLS / SPG / MEY / GOH / GUM / CHC / COM / ABZ / JAG / OBR / MOS / ROR  
 Fixture Material: Aluminum Die Cast  
 Cut-out Measurements: Ø 190mm / 7 1/2"  
 Upon Request: Unique Ceiling Thickness



#### ELECTRICAL

Lamp Type: LED (Zhaga Standard)  
 Input Wattage (W): 46.2  
 Total Output Wattage (W): 41.9  
 Dimming: Tri-Mode (Non-Dimming and Phase Dimming (120Vac only) and 0-10V Dimming)  
 Driver Included: No  
 Driver Location: Recessed Housing  
 Driver Type: Constant Current - Universal  
 Driver Class: Class 2  
 Housing: See components  
 Input Voltage (V): 120 - 277  
 Constant Current (MA): 1050

#### LED

Number of LEDs: 1  
 Color Temperature (°K): 2700 / 3000 / 3500 / 4000  
 Max. Delivered Lumen (lm): 4030 / 4130 / 4332 / 4420  
 CRI: >90 CRI  
 Lamp Life (hrs): 50000  
 Upon Request: Special Color Temperature RGB-W Tunable White Special LED

#### OPTICAL

Reflector°: 12 / 24 / 40  
 Adjustability: Rotational 355°; Tilt 30°  
 Upon Request: Special Beam Angles

#### RATINGS AND CERTIFICATIONS

Certified By: Certified for North American Standards  
 IP rating: IP44  
 Zaneen Group Inc. © 2024, T 1800-388-3382, F 416-247-9319, www.zaneen.com

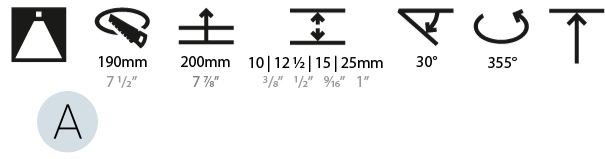
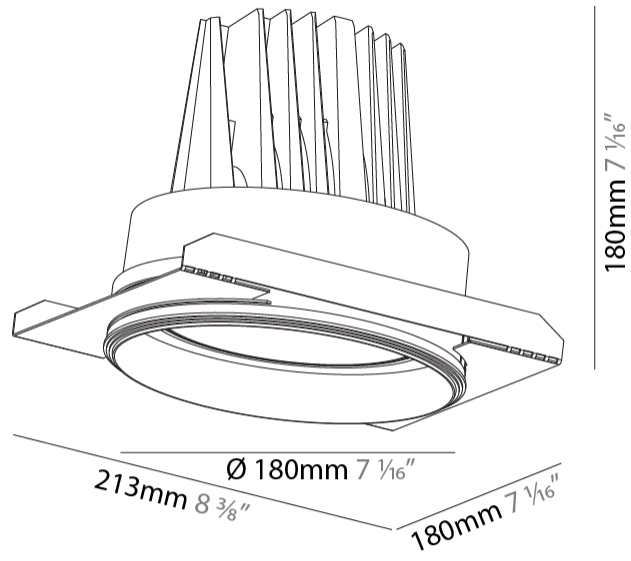

## MECHANIQ ROUND COMFORT TRIMLESS

A35010-

PROJECT	_____
TYPE	_____
SPECIFIER	_____
QUANTITY	_____
DATE	_____

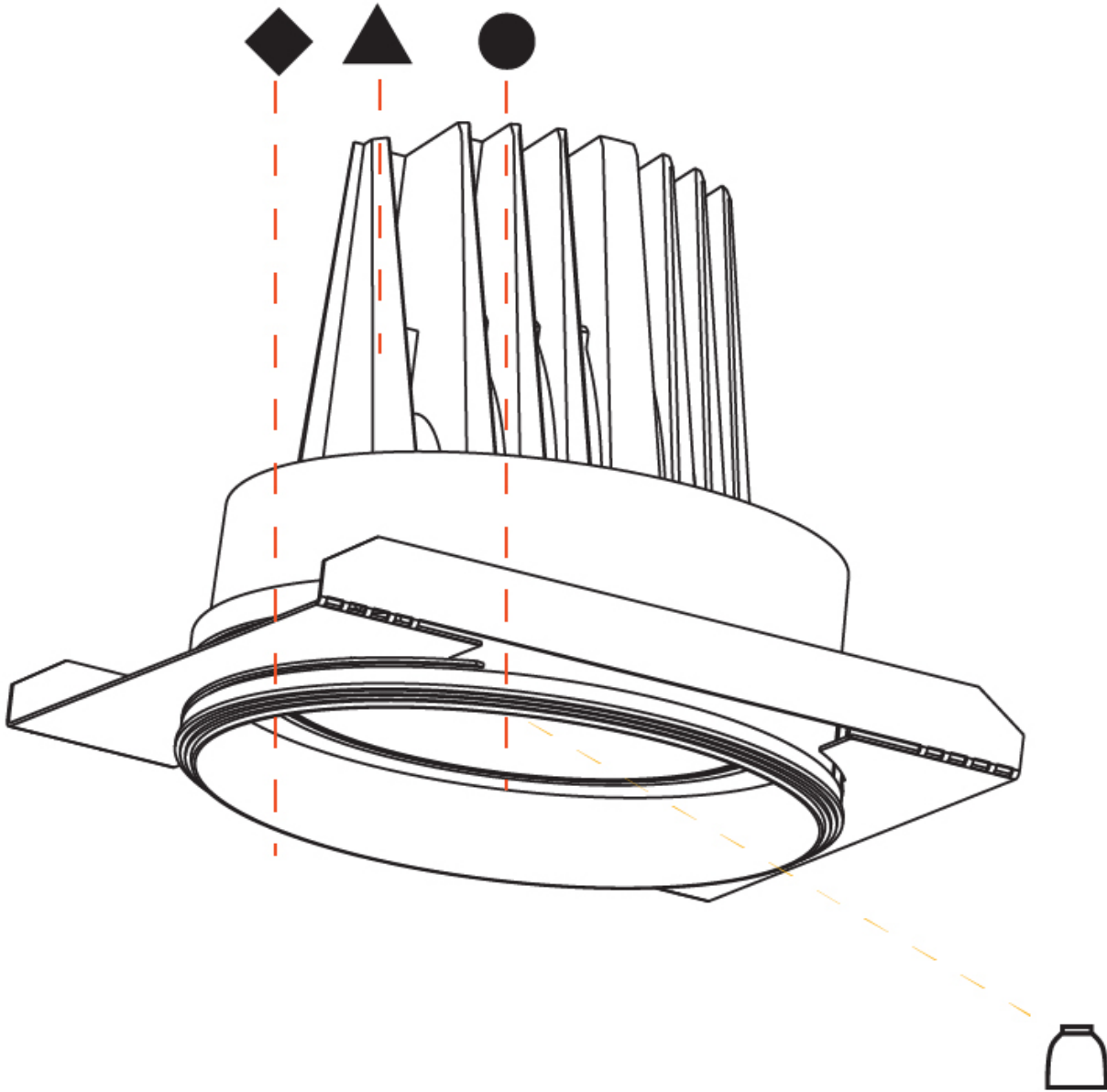

A

PROJECT	_____
TYPE	_____
SPECIFIER	_____
QUANTITY	_____
DATE	_____

## MECHANIQ ROUND COMFORT RECESSED

### A35049-

base number	Color Temperature	Finishes (Diamond)	Finishes (Triangle)	Finishes (Circle)
-------------	----------------------	-----------------------	------------------------	----------------------

- To build a product code in our configurator select the specify button on the base model # product page
- To build a manual product code on this datasheet choose from the options listed below in blue font and add the suffix to the base model #

#### GENERAL

Series: Mechaniq Round Comfort  
 Brand: Prolicht  
 Division: Architectural  
 Mounting Type: Recessed  
 Mounting Location: Ceiling  
 Subcategory: Downlight

#### PHYSICAL

Shape: Round  
 Diameter (mm): 130  
 Diameter (in): 5 1/8  
 Height (mm): 129  
 Height (in): 5 1/16  
 Ceiling Thickness (mm): 10 / 12.5 / 15  
 Ceiling Thickness (in): 3/8 or 1/2 or 9/16  
 Min. Recessing Depth (mm): 160  
 Min. Recessing Depth (in): 6 5/16  
 Light Distribution: Adjustable / Downlight  
 Weight (kg): 0.707  
 Weight (lbs): 1.56  
 Fixture Finish: SSR / BKV / CWI / CRY / HAB / UFT / ITA / RUA / FTG / MYG / LOD / PUS / FRO / FUP / KIA / POP / BLS / SPG / MEY / GOH / GUM / CHC / COM / ABZ / JAG / OBR / MOS / ROR  
 Fixture Material: Aluminum Die Cast  
 Cut-out Measurements: 120mm / 4 3/4"



#### ELECTRICAL

Lamp Type: LED (Zhaga Standard)  
 Total Output Wattage (W): 12 / 15  
 Dimming: Tri-Mode (Non-Dimming and Phase Dimming (120Vac only) and 0-10V Dimming)  
 Driver Included: No  
 Driver Location: Recessed Housing  
 Driver Type: Constant Current - Universal  
 Housing: See components  
 Input Voltage (V): 120 - 277  
 Constant Current (MA): 350

#### LED

Number of LEDs: 1  
 Color Temperature (°K): 2700 / 3000 / 3500 / 4000  
 Max. Delivered Lumen (lm): 830 / 930 / 1010 / 1030  
 CRI: >90 CRI  
 Lamp Life (hrs): 50000

#### OPTICAL

Reflector°: 8  
 Adjustability: Rotational 355°; Tilt 30°

#### RATINGS AND CERTIFICATIONS

Certified By: Certified for North American Standards  
 IP rating: IP20

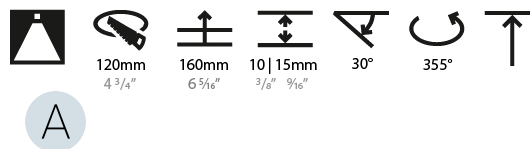
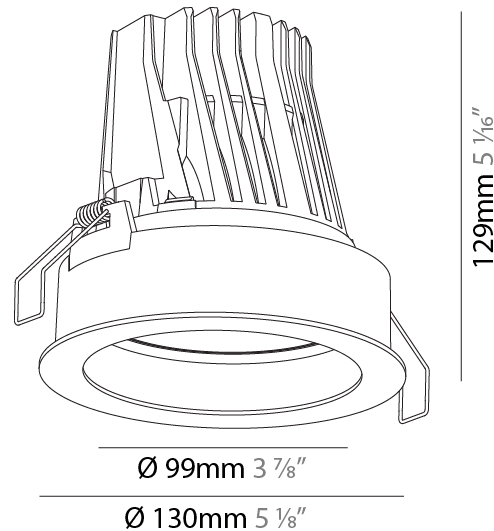

## MECHANIQ ROUND COMFORT RECESSED

A35049-

PROJECT

TYPE

SPECIFIER

QUANTITY

DATE

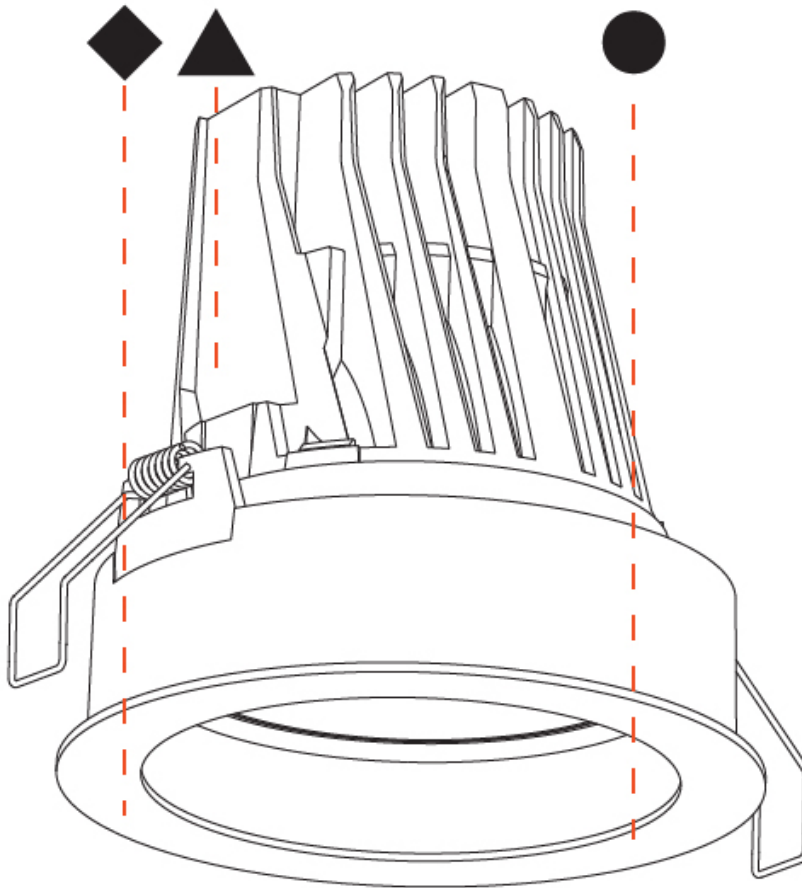

A



PROJECT
TYPE
SPECIFIER
QUANTITY
DATE

## MECHANIQ ROUND COMFORT RECESSED

### A35052-

base number	Color Temperature	Finishes (Diamond)	Finishes (Triangle)	Finishes (Circle)	Reflector Options
-------------	-------------------	--------------------	---------------------	-------------------	-------------------

- To build a product code in our configurator select the specify button on the base model # product page
- To build a manual product code on this datasheet choose from the options listed below in blue font and add the suffix to the base model #

#### GENERAL

Series: Mechaniq Round Comfort  
 Brand: Prolicht  
 Division: Architectural  
 Mounting Type: Recessed  
 Mounting Location: Ceiling  
 Subcategory: Downlight

#### PHYSICAL

Shape: Round  
 Diameter (mm): 130  
 Diameter (in): 5 1/8  
 Height (mm): 129  
 Height (in): 5 1/16  
 Ceiling Thickness (mm): 10 / 12.5 / 15  
 Ceiling Thickness (in): 3/8 or 1/2 or 9/16  
 Min. Recessing Depth (mm): 160  
 Min. Recessing Depth (in): 6 5/16  
 Light Distribution: Adjustable / Downlight  
 Weight (kg): 0.707  
 Weight (lbs): 1.56  
 Fixture Finish: SSR / BKV / CWI / CRY / HAB / UFT / ITA / RUA / FTG / MYG / LOD / PUS / FRO / FUP / KIA / POP / BLS / SPG / MEY / GOH / GUM / CHC / COM / ABZ / JAG / OBR / MOS / ROR  
 Fixture Material: Aluminum Die Cast  
 Cut-out Measurements: 120mm / 4 3/4"



#### ELECTRICAL

Lamp Type: LED (Zhaga Standard)  
 Total Output Wattage (W): 26.4  
 Dimming: Tri-Mode (Non-Dimming and Phase Dimming (120Vac only) and 0-10V Dimming)  
 Driver Included: No  
 Driver Location: Recessed Housing  
 Driver Type: Constant Current - Universal  
 Housing: See components  
 Input Voltage (V): 120 - 277  
 Constant Current (MA): 700

#### LED

Number of LEDs: 1  
 Color Temperature (°K): 2700 / 3000 / 3500 / 4000  
 Max. Delivered Lumen (lm): 2960 / 3030 / 3185 / 3250  
 CRI: >90 CRI  
 Lamp Life (hrs): 50000

#### OPTICAL

Reflector: 18 / 26 / 40  
 Adjustability: Rotational 355°, Tilt 30°

#### RATINGS AND CERTIFICATIONS

Certified By: Certified for North American Standards  
 IP rating: IP20

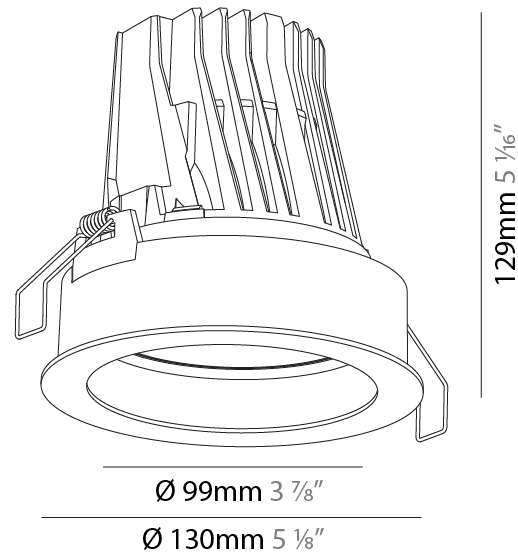

	120mm 4 3/4"	160mm 6 5/16"	10   15mm 3/8"   9/16"	30°	355°	↑
A						

## MECHANIQ ROUND COMFORT RECESSED

A35052-

PROJECT	_____
TYPE	_____
SPECIFIER	_____
QUANTITY	_____
DATE	_____

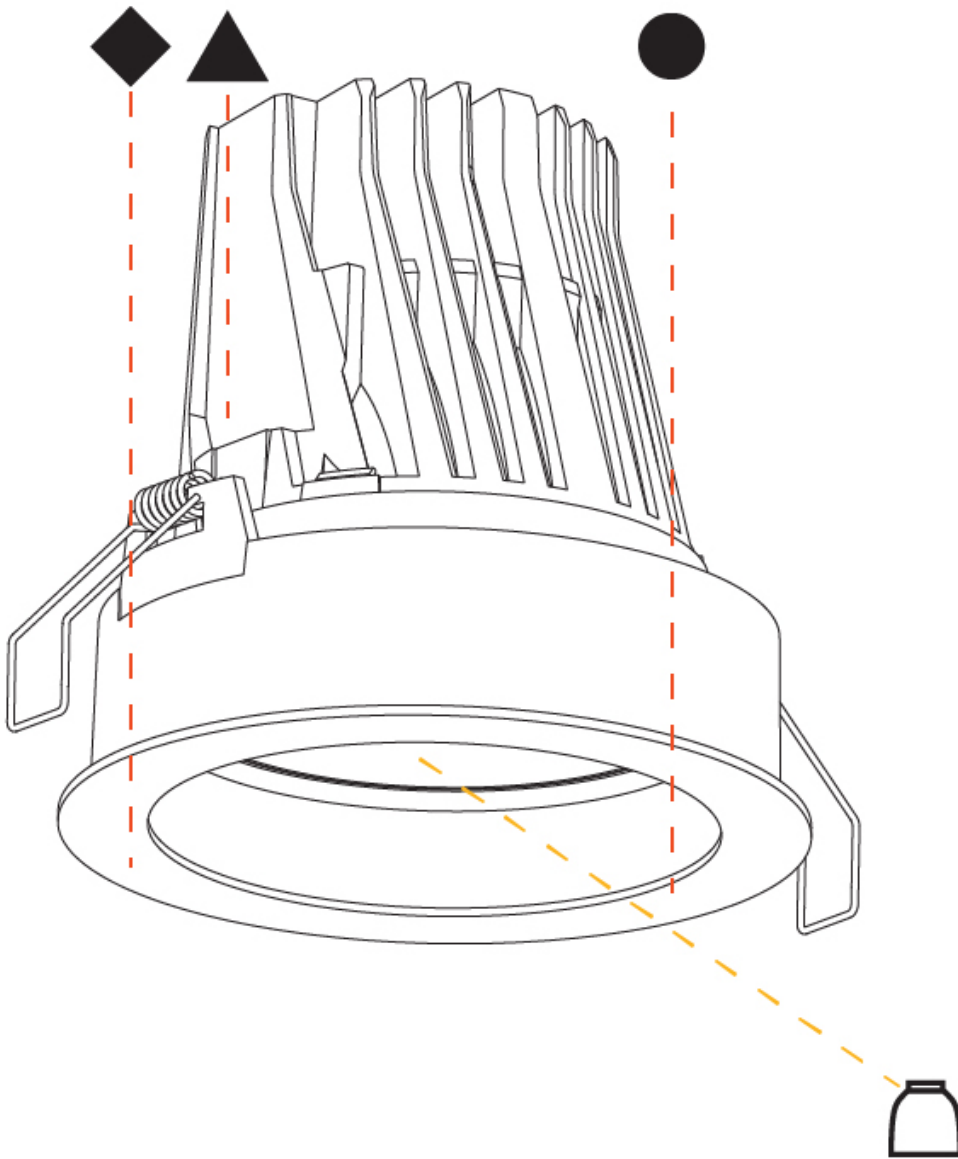

A

PROJECT	_____
TYPE	_____
SPECIFIER	_____
QUANTITY	_____
DATE	_____

## MECHANIQ ROUND COMFORT RECESSED

### A35055-

base number	Color Temperature	Finishes (Diamond)	Finishes (Triangle)	Finishes (Circle)
-------------	----------------------	-----------------------	------------------------	----------------------

- To build a product code in our configurator select the specify button on the base model # product page
- To build a manual product code on this datasheet choose from the options listed below in blue font and add the suffix to the base model #

#### GENERAL

Series: Mechaniq Round Comfort  
 Brand: Prolicht  
 Division: Architectural  
 Mounting Type: Recessed  
 Mounting Location: Ceiling  
 Subcategory: Downlight

#### PHYSICAL

Shape: Round  
 Diameter (mm): 182  
 Diameter (in): 7 3/16  
 Height (mm): 187  
 Height (in): 7 3/8  
 Ceiling Thickness (mm): 10 / 12.5 / 15  
 Ceiling Thickness (in): 3/8 or 1/2 or 9/16  
 Min. Recessing Depth (mm): 210  
 Min. Recessing Depth (in): 8 1/4  
 Light Distribution: Adjustable / Downlight  
 Weight (kg): 1.736  
 Weight (lbs): 3.83  
 Fixture Finish: SSR / BKV / CWI / CRY / HAB / UFT / ITA / RUA / FTG / MYG / LOD / PUS / FRO / FUP / KIA / POP / BLS / SPG / MEY / GOH / GUM / CHC / COM / ABZ / JAG / OBR / MOS / ROR  
 Fixture Material: Aluminum Die Cast  
 Cut-out Measurements: 177mm / 6 15/16"

#### ELECTRICAL

Lamp Type: LED (Zhaga Standard)  
 Total Output Wattage (W): 21.2  
 Dimming: Tri-Mode (Non-Dimming and Phase Dimming (120Vac only) and 0-10V Dimming)  
 Driver Included: No  
 Driver Location: Recessed Housing  
 Driver Type: Constant Current - Universal  
 Housing: See components  
 Input Voltage (V): 120 - 277  
 Constant Current (MA): 700

#### LED

Number of LEDs: 1  
 Color Temperature (°K): 2700 / 3000 / 3500 / 4000  
 Max. Delivered Lumen (lm): 1440 / 1490 / 1568 / 1600  
 CRI: >90 CRI  
 Lamp Life (hrs): 50000

#### OPTICAL

Reflector°: 8  
 Adjustability: Rotational 355°, Tilt 30°

#### RATINGS AND CERTIFICATIONS

Certified By: Certified for North American Standards  
 IP rating: IP20

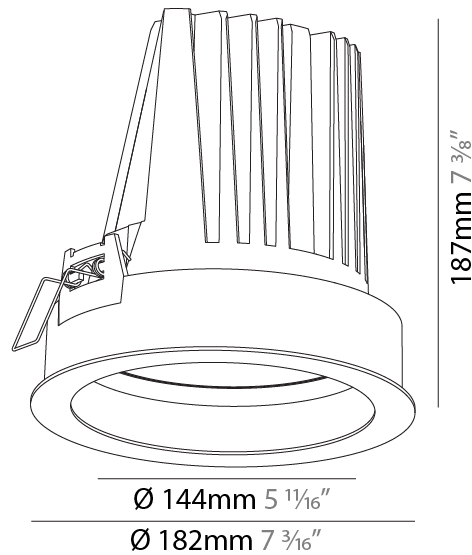

177mm 6 15/16"	210mm 8 1/4"	10   15mm 3/8"   9/16"	30°	355°		
A						

## MECHANIQ ROUND COMFORT RECESSED

A35055-

PROJECT	_____
TYPE	_____
SPECIFIER	_____
QUANTITY	_____
DATE	_____

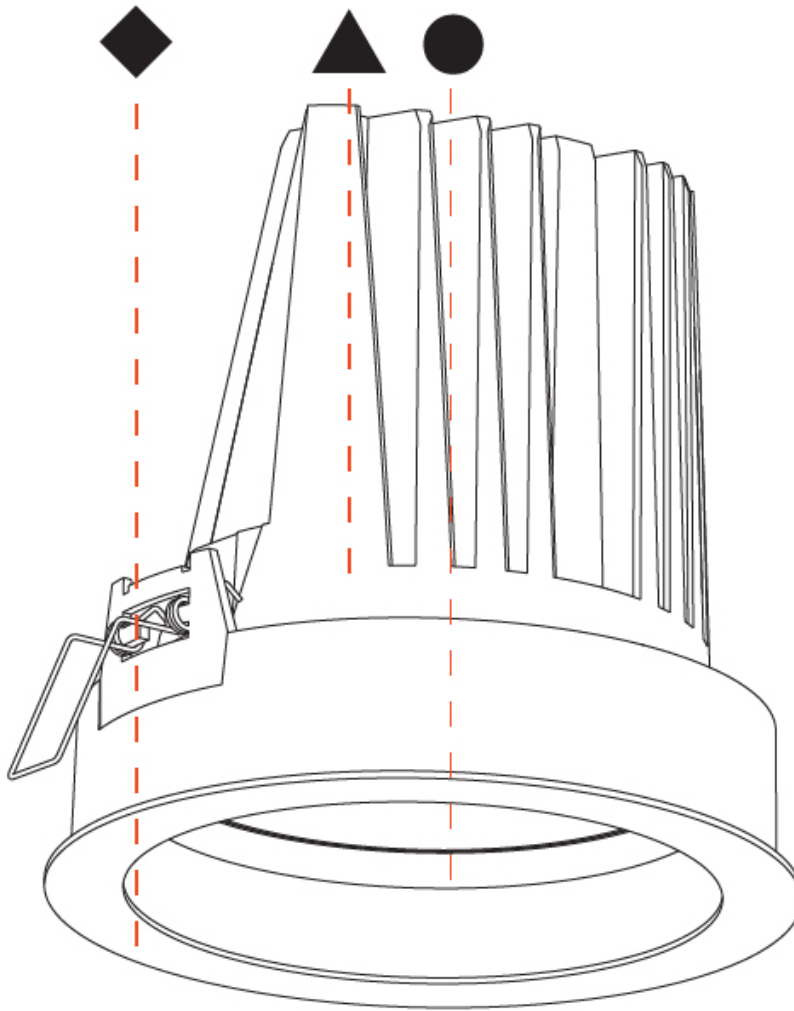

PROJECT	_____
TYPE	_____
SPECIFIER	_____
QUANTITY	_____
DATE	_____

## MECHANIQ ROUND COMFORT RECESSED

### A35058-

base number	Color Temperature	Finishes (Diamond)	Finishes (Triangle)	Finishes (Circle)	Reflector Options
-------------	-------------------	--------------------	---------------------	-------------------	-------------------

- To build a product code in our configurator select the specify button on the base model # product page
- To build a manual product code on this datasheet choose from the options listed below in blue font and add the suffix to the base model #

#### GENERAL

Series: Mechaniq Round Comfort  
 Brand: Prolicht  
 Division: Architectural  
 Mounting Type: Recessed  
 Mounting Location: Ceiling  
 Subcategory: Downlight

#### PHYSICAL

Shape: Round  
 Diameter (mm): 182  
 Diameter (in): 7 3/16  
 Height (mm): 187  
 Height (in): 7 3/8  
 Ceiling Thickness (mm): 10 / 12.5 / 15  
 Ceiling Thickness (in): 3/8 or 1/2 or 9/16  
 Min. Recessing Depth (mm): 210  
 Min. Recessing Depth (in): 8 1/4  
 Light Distribution: Adjustable / Downlight  
 Weight (kg): 1.736  
 Weight (lbs): 3.83  
 Fixture Finish: SSR / BKV / CWI / CRY / HAB / UFT / ITA / RUA / FTG / MYG / LOD / PUS / FRO / FUP / KIA / POP / BLS / SPG / MEY / GOH / GUM / CHC / COM / ABZ / JAG / OBR / MOS / ROR  
 Fixture Material: Aluminum Die Cast  
 Cut-out Measurements: 177mm / 6 15/16"

#### ELECTRICAL

Lamp Type: LED (Zhaga Standard)  
 Total Output Wattage (W): 41.9  
 Dimming: Tri-Mode (Non-Dimming and Phase Dimming (120Vac only) and 0-10V Dimming)  
 Driver Included: No  
 Driver Location: Recessed Housing  
 Driver Type: Constant Current - Universal  
 Housing: See components  
 Input Voltage (V): 120 - 277  
 Constant Current (MA): 1050

#### LED

Number of LEDs: 1  
 Color Temperature (°K): 2700 / 3000 / 3500 / 4000  
 Max. Delivered Lumen (lm): 4030 / 4130 / 4342 / 4430  
 CRI: >90 CRI  
 Lamp Life (hrs): 50000

#### OPTICAL

Reflector°: 12 / 24 / 40

#### RATINGS AND CERTIFICATIONS

Certified By: Certified for North American Standards  
 IP rating: IP20

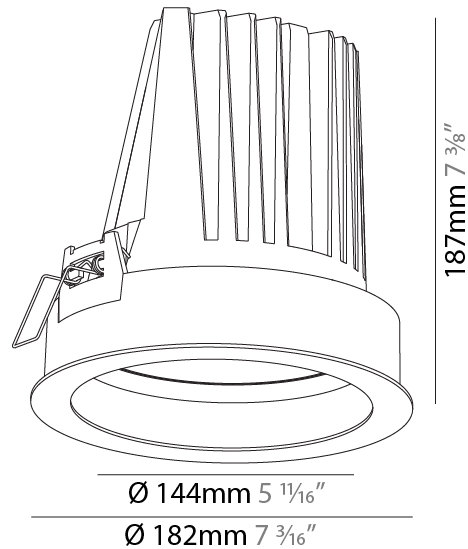

177mm 6 15/16"	210mm 8 3/4"	10   15mm 3/8"   9/16"	30°	355°		
A						

## MECHANIQ ROUND COMFORT RECESSED

A35058-

PROJECT	_____
TYPE	_____
SPECIFIER	_____
QUANTITY	_____
DATE	_____

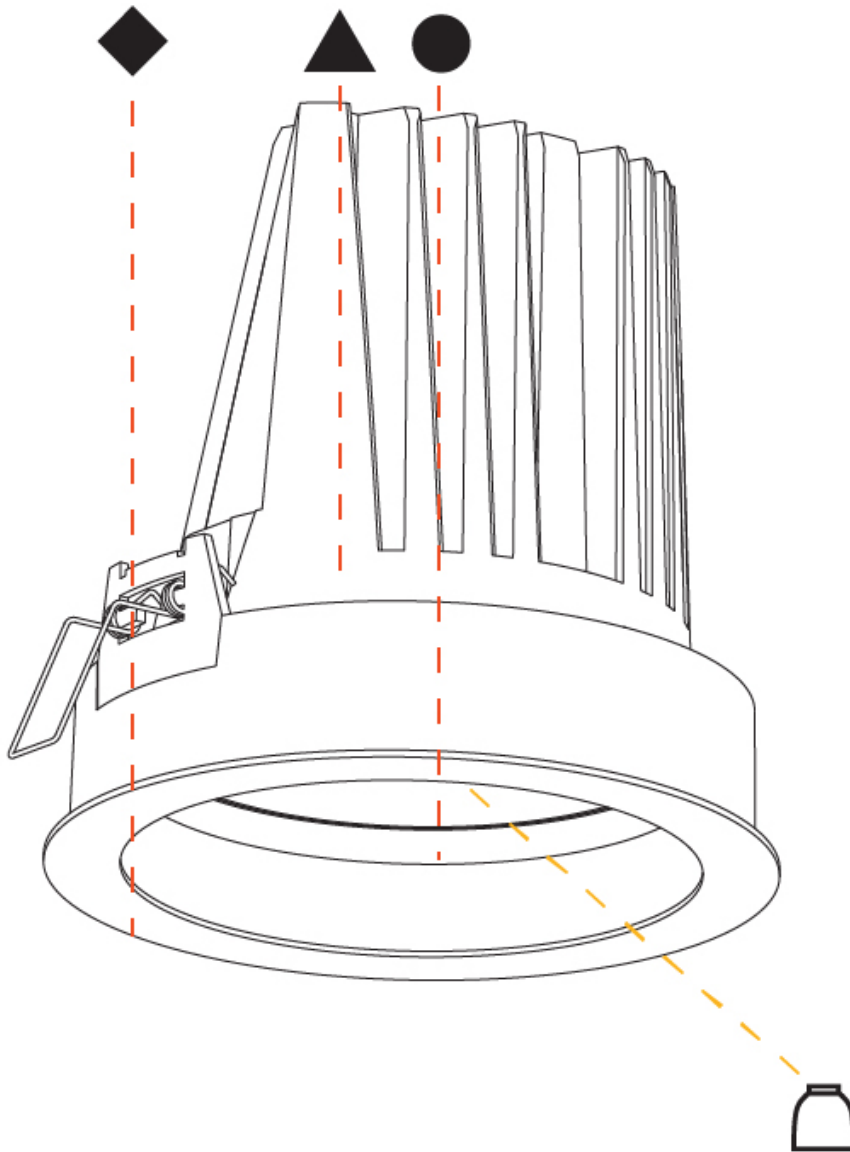

A

## MECHANIQ ROUND COMFORT

### COLOR FINISH CHART

PROJECT
TYPE
SPECIFIER
QUANTITY
DATE

#### Fixture Finish



**Digital:** Not all screens are calibrated the same, and therefore, colors will appear differently between screens.





































































**Physical:** When texture is involved, there will be variations in color, character and tone within a product series and between product families.

**Gun Metal:** No Gun Metal finish is alike. It combines a mixture of transparent and black color particles which ensures a highly individual effect and no luminaire being identical.











**Champagne Cream, Copper Mine, Ancient Bronze + Jazz Gold:** These finishes have slight fading from specific powder coating production. Each luminaire will slightly vary.













### LEGEND

	floor-mounted		pivotal		special LED (upon request) RGB, RGBW, tunable, gold+, meat+, art+, fashion+
	wall and ceiling: recessed and surface mounted		rotating		warm dim / natural dimming LED
	ceiling-mounted and wall-mounted		illuminate tilted		rechargeable battery powered
	wall-mounted		color of suspension cable		fixture with natural vivid LED (upon request)
	omni-directional light distribution		length of suspension cable		color rendering index
	direct light distribution		reflector degree selection		color temperature
	direct/indirect light distribution		super spot		lumen (luminous flux)
	indirect light distribution		lens		efficacy (lumens per watt)
	asymmetric light distribution		lens pack		Unified Glare Rating (UGR) range from 5-40
	aura light distribution		shine ring		marine grade (AISI 316 stainless steel)
	round wall or ceiling cut-out		integrated shine ring with diffuser		walk on
	square wall or ceiling cut-out		free individual colors 01-29		drive on
	the supplied jig specifies the cutout dimensions		individual colors: 00 (free of charge), 01-25 (extra charge)		Dark Sky Compliance
	minimum distance (meters) lamp - object		luminaire part to be colored (F1)		Americans with Disabilities Act (less than 4" off the wall located between 27"-84" from floor)
	recessed depth		luminaire part to be colored (F2)		lamp protected against explosion
	ceiling thickness in mm		luminaire part to be colored (F3)		blown glass using traditional methods by master glass blower
	ceiling thickness selection		luminaire part to be colored (F4)		acoustic material
	dimnable DP (phase), DV (0-10V), DD (dali), DS (step-dim)		luminaire part to be colored (F5)		protection class I, protection insulation
	included or excluded LED driver/transformer/control gear		color of 3-circuit adaptor		protection class II, protection insulation
	separately switchable		indirect diffuser		ETL Certified to UL and CSA Standards
	sensor		direct diffuser		UL Certified to UL and CSA Standards
	remote control		ball-proof (upon request)		CSA Certified to UL and CSA Standards
	available upon request		accessory		Certified for North American Standards

### IP RATING

	protected against ingress of solid bodies greater than 12.5mm (finger)
	protected against ingress of solid bodies greater than 2.5mm protected against sprays of water up to 60 degrees from the vertical (rain)
	protected against ingress of solid bodies greater than 1mm (wire) no protection against the ingress of moisture
	protected against ingress of solid bodies greater than 1mm (wire) protected against sprays of water up to 60 degrees from the vertical (rain)
	protected against ingress of solid bodies greater than 1mm (wire) protected against water splashed from all directions
	protected against limited ingress of dust (wet rooms/covered outdoor areas) protected against water splashed from all directions
	protected against ingress of dust protected against jets of water
	protected against ingress of dust protected against powerful jets of water or heavy seas
	protected against ingress of dust protected against immersion of water between 15cm - 1m for 30 minutes
	protected against ingress of dust protected against immersion of water under pressure for long periods

### IK RATING

	protected against 0.14 joules impact (equivalent to 0.25kg mass dropped from 56mm above the surface)
	protected against 0.2 joules impact (equivalent to 0.25kg mass dropped from 80mm above the surface)
	protected against 0.35 joules impact (equivalent to 0.25kg mass dropped from 140mm above the surface)
	protected against 0.5 joules impact (equivalent to 0.25kg mass dropped from 200mm above the surface)
	protected against 0.7 joules impact (equivalent to 0.25kg mass dropped from 280mm above the surface)
	protected against 1 joules impact (equivalent to 0.25kg mass dropped from 400mm above the surface)
	protected against 2 joules impact (equivalent to 0.5kg mass dropped from 400mm above the surface)
	protected against 5 joules impact (equivalent to 1.7kg mass dropped from 300mm above the surface)
	protected against 10 joules impact (equivalent to 5.0kg mass dropped from 200mm above the surface)
	protected against 20 joules impact (equivalent to 5.0kg mass dropped from 400mm above the surface)